



Flash Mobile

**Battery Powered
Key Duplicator**

Edge Cut and Cruciform Keys





FLASH MOBILE

Flash Mobile

Lightweight, Compact, Portable

Powered by 24V 2900mAh battery, the Flash Mobile edge cut key duplicator is an ideal choice for on-site mobile jobs.

The Flash Mobile will easily duplicate most cylinder, cruciform, large bow and long blade keys; including the larger, oversize type automotive keys. Optional kit available for safe-deposit style flat keys

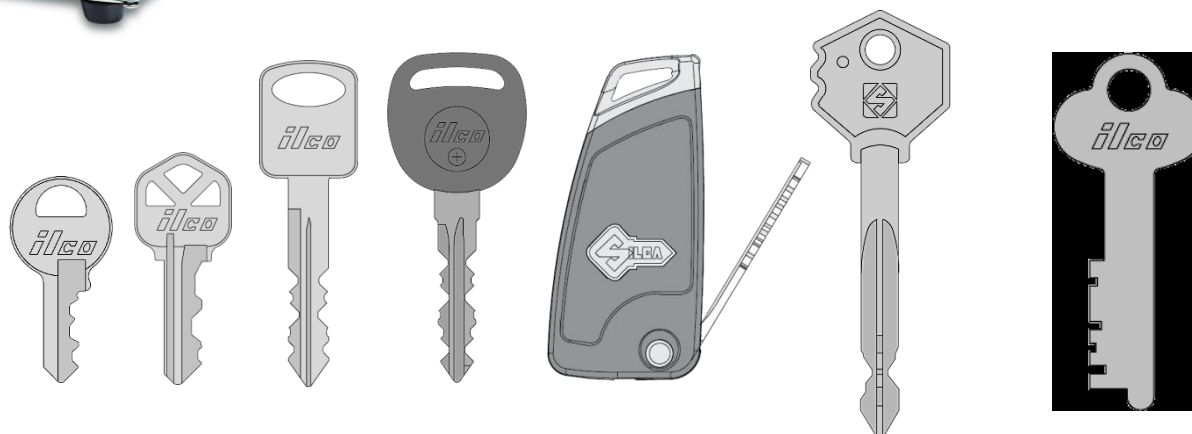

Flash Mobile Features

- Powered by a 2900mAh battery
- Full battery charge takes up to 3 hours
- Once charged, it lasts 2-3 days (depending on usage) OR can duplicate 300 brass keys / 180 steel keys in a single charge.
- Built-in 'Tynex' de-burring brush
- Machine warranty – 2 years (excluding battery)
- CE & ROHS Compliant



Teflon® is the registered trademark of E.I. du Pont de Nemours and Company or its affiliates

Nickel plated Components

Flash Mobile Features (continued)



- Rotating knob for precise horizontal movement
- Teflon[®] coated bushings guarantee a smooth, quiet movement and provides protection to the carriage and shaft
- Front lever handle allows for manual carriage movement
- Nickel plated cutter screw, tracer, tracer collar, key stop and key stop assembly, clamp knobs, carriage shaft knob and carriage assembly.
- Carry handle on back of machine for ease of transport

Teflon[®] is the registered trademark of E.I. du Pont de Nemours and Company or its affiliates

Ergonomic, Plastic Clamp Handles
3½" (88.9 mm) spacing between
clamps

Tracer Point
Adjustment

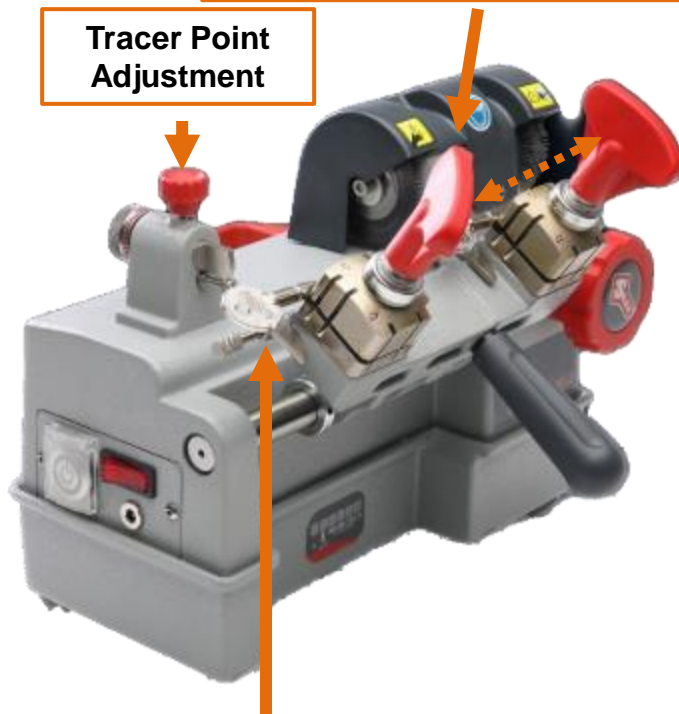

Spring Loaded
Shoulder Gauge

Flash Mobile Features (continued)

- 3-1/2" (88.9 mm) spacing between clamps accommodates most cylinder, and cruciform keys; including large head and flip-type automotive keys
- Tracer point adjustment feature provides fast and precise calibration
- Ergonomically designed clamp handles tighten with a minimum of force to hold keys securely
- Spring loaded shoulder gauge with adjustable tabs.
- Fast 2200 RPM cutter speed for smooth and precise cutting

Flash Mobile Features (continued)

**Aluminum Titanium
Nitride Coated
Cutter with Nickel
plated cutter screw**

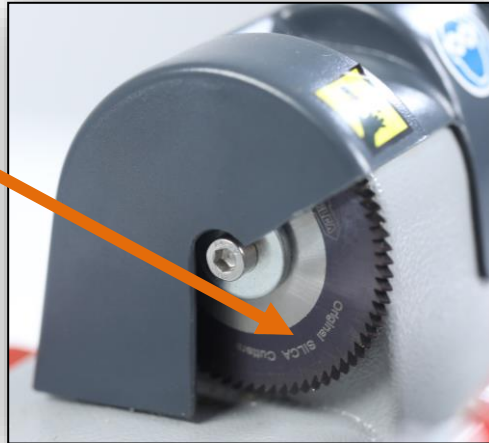

- AlTiN coated cutter for longer life, heat and oxidation resistance
- Nickel plated cutter screw
- Nickel plated 4-Position (four-sided) clamp provides flexibility to clamp and index a variety of edge cut and cruciform keys; including double sided automotive keys.

**Nickel Plated
4-Position
Clamp**

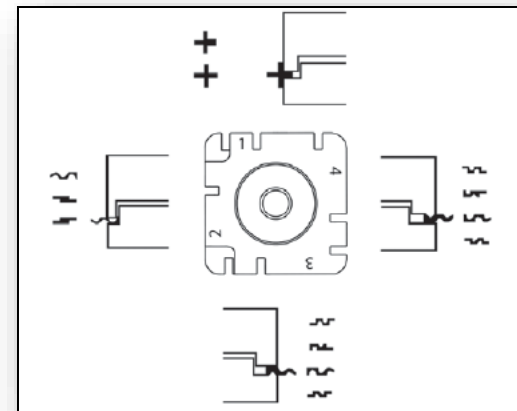



Flash Mobile Features - Safety

- Enclosed Motor for quiet operation
- Main rocker switch
- Protective cover on cutter switch to prevent accidental start
- Inverted frame protects the PCB and battery from key shavings.
- Easy battery installation

Enclosed
Motor
Inverted
Frame



2 switches

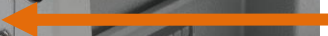

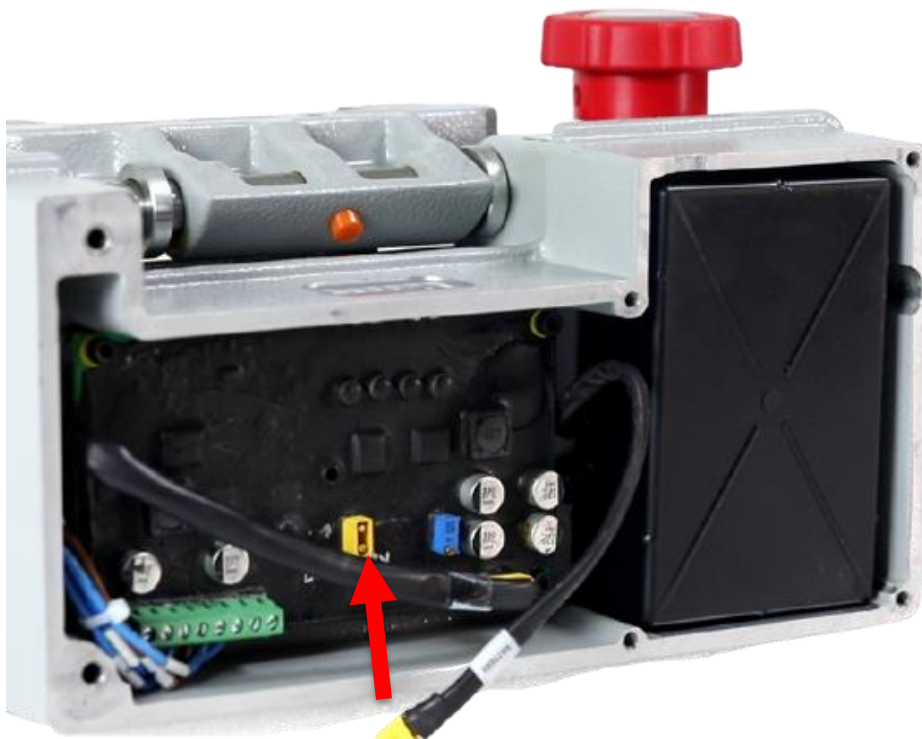

Flash Mobile Lithium-ion Battery

- Due to shipping regulations, the battery cannot be connected to the PCB during shipping.
- Instructions are included with the machine for connecting the battery.
- Install the battery by removing the bottom plate on the machine and plug the marked cable into the battery socket.
- **Don't start the machine until the battery is connected.**
- **Once connected, plug charger into machine to charge the battery.**
- **Battery must be fully charged before mobile use.**
- **The battery is considered a consumable and therefore is not covered under the machine warranty.**

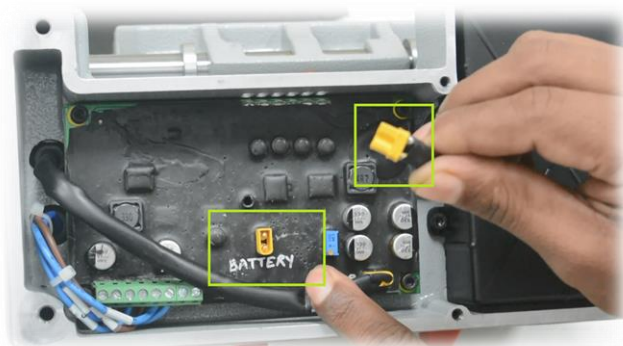

Battery Charge Indicator

- LED lights indicate battery levels
 - Red: Charging
 - Green (battery symbol on extreme right indicates full charge)
 - Green (4 battery symbols on left indicate battery level once the battery starts to be used)

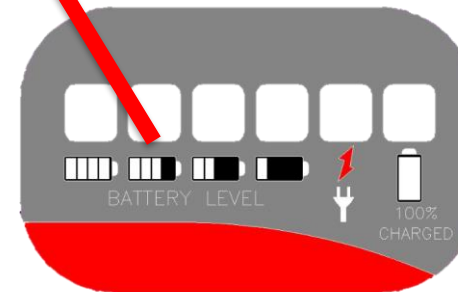



Accessories provided





Technical Data

Battery	24V Lithium-ion battery, 2900mAh Part number BJ1430XXXX D950070ZR
Battery Life	>300 brass keys or 200 steel keys in a single charge
Motor	120W, 2200 RPM +/- 10%
Cutter	Part No: BC0600XXXX AlTiN (Aluminum Titanium Nitride) coated Target cutter life 1,100 brass keys
Brush	Part Number: BJ1184XXXX, Nylon Brush
Clamp	Part Number: BJ1137XXXX 4-Position, rotating; nickel plated
Movement	Rectified carriage shaft and rack
Dimensions	Width: 12.6" (320 mm)
	Depth: 10.5" (255 mm) with carry handle
	Height: 10.5" (255 mm)
Weight	15.4 lbs (7 kg)



Competition Comparison		
	Flash Mobile	Xhorse
Deburring Brush	Yes	No
Battery Capability (mAh)	2900	2600
LED Battery charge indicator	Yes	Yes
DC Motor Wattage	120	110
RPM	2200	1800
Brass keys cut in a single charge	>300	100
Steel keys cut in a single charge	200	60
LED Light	No	Yes
Safety Switch Cover	Yes	No
PCB & Battery Mounting	Separated from Motor by Frame	In one place
Warranty	24 Months	12 Months
Weight	15.4 lbs	23.8 lbs
Optional Safe Deposit Keys	Yes	No
Accessory Case	No	Yes
Mounting Bracket	Yes	No





Flash Mobile

Mechanical Key Duplicator



www.ilco.us

Kaba Ilco Corp.
400 Jeffries Road
Rocky Mount, NC 27804
Phone: 1-800-334-1381

In compliance with current regulations relating to industrial/intellectual property, we hereby state that the trademarks or tradenames mentioned in this document are the exclusive property of the authorized manufacturers. Trademarks or trade names are used for the purposes of information. All information and illustrations in this document are for guidance only.

We reserve the right to alter products designs, dimensions or info to improve the products quality. The contents of this document are fully protected by copyright and may not be copied or reproduced in any form, without written permission from Kaba Ilco Corp. Any controversy shall be settled by the Courts of Justice where the company has its headquarters, with express exclusion of any other court.

Member of the dorma+kaba Group

